



Thermo Scientific

# Sorvall ST 8 Centrifuge

## Instruction Manual

50138912-a

February 2013

Visit us online to register your warranty.  
[www.thermoscientific.com/labwarranty](http://www.thermoscientific.com/labwarranty)



Thermo Scientific

# **Sorvall ST 8 Centrifuge**

## **Instruction Manual**

50138912-a

February 2013

© 2013 Thermo Fisher Scientific Inc. All rights reserved.

Delrin, TEFLON, and Viton are registered trademarks of DuPont. Noryl is a registered trademark of SABIC. POLYCLEAR is a registered trademark of Hongye CO., Ltd. Hypaque is a registered trademark of Amersham Health As. RULON A and Tygon are registered trademarks of Saint-Gobain Performance Plastics. Alconox is a registered trademark of Alconox. Ficoll is a registered trademark of GE Healthcare. Haemo-Sol is a registered trademark of Haemo-Sol. Triton X-100 is a registered trademark of Sigma-Aldrich Co. LLC.

All other trademarks are the property of Thermo Fisher Scientific Inc. and its subsidiaries.

Thermo Fisher Scientific Inc. provides this document to its customers with a product purchase to use in the product operation. This document is copyright protected and any reproduction of the whole or any part of this document is strictly prohibited, except with the written authorization of Thermo Fisher Scientific Inc.

Country of Origin (manufacturer):

Thermo Fisher (Suzhou) Instruments Co., Ltd.  
No. 297 Taishan Road, New District, Suzhou, Jiangsu  
P. R. China

Importer for Europe (authorised representative):

Thermo Electron LED GmbH  
Robert-Bosch-Straße 1  
D - 63505 Langenselbold  
Germany

The contents of this document are subject to change without notice. All technical information in this document is for reference purposes only. System configurations and specifications in this document supersede all previous information received by the purchaser.

The pictures published within this manual are for reference only. The values shown on your centrifuge might differ.

**Thermo Fisher Scientific Inc. makes no representations that this document is complete, accurate or errorfree and assumes no responsibility and will not be liable for any errors, omissions, damage or loss that might result from any use of this document, even if the information in the document is followed properly.**

This document is not part of any sales contract between Thermo Fisher Scientific Inc. and a purchaser. This document shall in no way govern or modify any Terms and Conditions of Sale, which Terms and Conditions of Sale shall govern all conflicting information between the two documents.

Original instruction manual 50138912-a printed in February 2013.

## WEEE Compliance

This product is required to comply with the European Union's Waste Electrical & Electronic Equipment (WEEE) Directive 2002/96/EC. It is marked with the following symbol:



Thermo Fisher Scientific has contracted with one or more recycling or disposal companies in each European Union (EU) Member State, and these companies should dispose of or recycle this product. See [www.thermo.com/rohswcee](http://www.thermo.com/rohswcee) for further information on Thermo Fisher Scientific's compliance with these Directives and the recyclers in your country.

<b>Preface</b> .....	<b>9</b>
<b>Items Supplied</b> .....	<b>9</b>
<b>Intended Use</b> .....	<b>9</b>
<b>Precautions</b> .....	<b>11</b>
<b>Introduction and Description</b> .....	<b>15</b>
Characteristics .....	16
Technical Data .....	17
Directives, Standards and Guidelines .....	18
Functions and Features .....	19
Mains Supply .....	19
Rotor Selection .....	20
<b>Before Use</b> .....	<b>21</b>
Before Setting up .....	22
Location .....	22
Transporting the Centrifuge .....	23
Aligning the Centrifuge .....	23
Mains Connection .....	24
Storage .....	24
Shipping the Centrifuge .....	25
<b>Control Panel</b> .....	<b>27</b>
Control Panel .....	28
Keys .....	28
<b>Operation</b> .....	<b>29</b>
Switch on Centrifuge .....	30
Open Lid .....	30
Close Lid .....	30
Rotor Installation .....	31
Entering Parameters .....	32
Programs .....	34
Centrifugation .....	35
Short-term Centrifugation .....	37
Removing the Rotor .....	37
Aerosol-tight Rotors .....	38
Aligning the Centrifuge .....	38
<b>System Menu</b> .....	<b>39</b>
Description .....	41

<b>Maintenance and Care</b> .....	<b>45</b>
Cleaning Intervals .....	46
Cleaning .....	46
Disinfection .....	48
Decontamination .....	49
Autoclaving .....	50
Thermo Fisher Scientific Service .....	50
<b>Disposal</b> .....	<b>51</b>
<b>Troubleshooting</b> .....	<b>53</b>
Mechanical Emergency Door Release .....	54
Troubleshooting by Guide .....	55
When to Contact Customer Service .....	57
<b>Chemical Compatibility Chart</b> .....	<b>59</b>
<b>Contact</b> .....	<b>65</b>

## Preface

Before starting to use the centrifuge, read through this instruction manual carefully and follow the instructions.

The information contained in this instruction manual is the property of Thermo Fisher Scientific; it is forbidden to copy or pass on this information without explicit approval.

Failure to follow the instructions and safety information in this instruction manual will result in the expiration of the sellers warranty.

## Items Supplied

Item	Quantity	Check
Thermo Scientific Sorvall ST 8 Centrifuge	1	<input type="checkbox"/>
Power supply cable	1	<input type="checkbox"/>
Instruction manual	1	<input type="checkbox"/>

If any parts are missing, please contact your nearest Thermo Fisher Scientific representative.

## Intended Use

This centrifuge is a laboratory product used to separate substance mixtures of different densities.

This centrifuge can become an In-vitro-diagnostics device (Directive 98/79/EC), if used together with the hematocrit rotor and his accessories.

The hematocrit value is determined using the instructions written in the instruction manual of the hematocrit rotor. The instructions are based upon the reference method following DIN 58933, allowing to determinate the erythrocyte volume fraction within the blood.

This centrifuge has to be operated by trained specialists only.



## Symbols used on the centrifuge



This symbol refers to general hazards. Follow the instructions in the instruction manual in any case.



This symbol refers to biological hazards..

Observe the information contained in the instruction manual to keep yourself and your environment safe.



This symbol refers to information on hazards, described within the manual.



This symbol refers to disconnect mains before transporting or servicing the centrifuge.



This Symbol refers to check, if the rotor is installed correct by lifting it slightly at the handle. See “Rotor Installation” on [page 31](#).

## Symbols used in the manual

Observe the information contained in the instruction manual to keep yourself and your environment safe.



This symbol refers to general hazards.

CAUTION means that material damage could occur.

WARNING means that injuries or material damage or contamination could occur.



This symbol refers to biological hazards.



This symbol refers to electrical hazards.

# Precautions

A trained specialist can be a laboratory assistant or medical technologist.



## WARNING

- Plug the centrifuge only into sockets which have been properly grounded.
- If a hazardous situation occurs, turn off the power supply to the centrifuge and leave the area immediately.

**Note** In order to ensure safe operation of the Thermo Scientific Sorvall ST 8 Centrifuge, general safety regulations must be followed: Mind the regulations in your country.

It is the general obligation of the operator to make sure, that the proper protective clothing is used. Mind the „Laboratory Biosafety Manual“ of the World Health Organization (WHO) and the regulations in your country.

The work environment should guarantee the following:

## WARNING

- Maintain a radius of at least 30 cm around the centrifuge.
- Implementation of special measures which ensure that no one can approach the centrifuge for longer than absolutely necessary while it is running.



The power supply must be interrupted in case of an emergency. Turn off the centrifuge at the main switch. The mains plug must be freely accessible at all times. Pull out the power supply plug or disconnect the power supply in an emergency.

If the centrifuge is running, press the STOP key to shut it down.

In case of rotor failure the centrifuge can be damaged. Leave the room. Inform customer service.



## WARNING

Do not open the centrifuge, while it is running.



**WARNING** In any case of mechanical breakdown rotor failure, like burst of the rotor, breaking bottles or shaft crack, the centrifuge is not aerosol-tight.

**Note** Not following these instruction can cause damage.

**WARNING**

In order to ensure safe operation of the Thermo Scientific Sorvall ST 8 Centrifuge, the following general safety regulations must be followed:

- The centrifuge should be operated by trained specialists only.
- The centrifuge is to be used for its intended use only.
- Do not move the centrifuge while it is running.
- Do not lean on the centrifuge.
- Do not place anything on top of the centrifuge during a run. This applies also for the rotor landing pad.
- Use only rotors and accessories for this centrifuge which have been approved by Thermo Fisher Scientific. Exceptions to this rule are commercially available glass or plastic centrifuge tubes, provided they have been approved for the speed or the RCF value of the rotor.
- Contact the the customer service, if the centrifuge and the rotors are in any conspicuous condition, e.g. showing signs of corrosion and/or cracks.
- Do not use rotors which show any signs of corrosion and/or cracks.
- Do not touch the mechanical components of the rotor and do not make any changes to the mechanical components.
- Use only with rotors which have been properly installed. Follow the instructions on the Thermo Scientific Auto-Lock rotor exchange in section “[Rotor Installation](#)” on [page 31](#).
- Use only with rotors which have been loaded properly. Follow the instructions given in the rotor manual.
- Never overload the rotor. Follow the instructions given in the rotor manual.
- Never start the centrifuge when the door is open.
- Never open the door until the rotor has come to a complete stop and this has been confirmed in the display.
- The door emergency release may be used in emergencies only to recover the samples from the centrifuge, e.g. during a power failure (see section “[Mechanical Emergency Door Release](#)” on [page 54](#)).
- Never use the centrifuge if parts of its cover panels are damaged or missing.
- Do not touch the electronic components of the centrifuge or alter any electronic or mechanical components.
- Please observe the safety instructions.



**WARNING**

Please pay particular attention to the following aspects:



- Location: well-ventilated environment, set-up on a level and rigid surface with adequate load-bearing capacity.
- Rotor installation: make sure the rotor is locked properly into place before operating the centrifuge.
- Especially when working with corrosive samples (salt solutions, acids, bases), the accessory parts and vessel have to be cleaned carefully.
- Always balance the samples.

Centrifuging hazardous substances:

- Do not centrifuge explosive or flammable materials or substances which could react violently with one another.
- The centrifuge is neither inert nor protected against explosion. Never use the centrifuge in an explosion-prone environment.
- Do not centrifuge inflammable substances.

**Remaining risk: Improper use can cause damages, contamination, and injuries with fatal consequences.**

- Do not centrifuge toxic or radioactive materials or any pathogenic micro-organisms without suitable safety precautions.

If centrifuging any hazardous materials mind the „Laboratory Biosafety Manual“ of the World Health Organization (WHO).



When centrifuging microbiological samples from the Risk Group II (according to the "Laboratory Biosafety Manual" of the World Health Organization (WHO)), aerosol-tight biological seals have to be used.

Look on the internet page of the World Health Organization ([www.who.int](http://www.who.int)) for the „Laboratory Biosafety Manual“.

For materials in a higher risk group, extra safety measures have to be taken.

- If toxins or pathogenic substances have gotten into the centrifuge or its parts, appropriate disinfection measures have to be taken (see “[Disinfection](#)” on [page 48](#)).

**Remaining risk: Improper use can cause damages, contamination, and injuries with fatal consequences.**

- Highly corrosive substances which can cause material damage and impair the mechanical stability of the rotor, should only be centrifuged in corresponding protective tubes.

**Note** If used for Foodstuffs machinery, for cosmetics or pharmaceutical products, only use closed or aerosol-tight containers for centrifugation.



# Introduction and Description

## Contents

- “Characteristics” on page 16
- “Technical Data” on page 17
- “Directives, Standards and Guidelines” on page 18
- “Functions and Features” on page 19
- “Mains Supply” on page 19
- “Rotor Selection” on page 20

## Characteristics

The Thermo Scientific Sorvall ST 8 Centrifuge is an in-vitro diagnostics device according to the In-Vitro Diagnostics Directive 98/79/EC.

Several rotors with a wide range of tubes can be used.

The set speed is reached within seconds. The maintenance-free induction motor ensures quiet and low-vibration operation even at high speeds, as well as guaranteeing a very long lifetime.

The user-friendly control panel makes it easy to pre-set the speed, RCF value, running time, temperature, and running profile (acceleration and braking curves). You can choose between the display of speed and RCF or the entry mode.

These settings can be changed even while the centrifuge is running.

With the help of the PULSE key, you can also centrifuge a sample for just a few seconds.

The Thermo Scientific Sorvall ST 8 Centrifuge is equipped with various safety features:

- The housing and the interior consist of steel plate, the rotor chamber of stainless steel, while the front panel is made of high-impact resistant plastic.
- The lid is equipped with a view port and a lock.
- The lid of the centrifuge can only be opened while the centrifuge is switched on and the rotor has come to a complete stop. The centrifuge cannot be started until the lid has been closed properly.
- The integrated rotor detection systems ensures that no inadmissible speed settings can be preselected.
- Electronic imbalance recognition
- Lid emergency release: For emergencies only, e.g. during power failures (see [“Mechanical Emergency Door Release”](#) on page 54)

## Technical Data

The technical data of the Thermo Scientific Sorvall ST 8 Centrifuge is listed in the following table.

**Tabelle 1-1.** Technical Data Thermo Scientific Sorvall ST 8 Centrifuge

Feature	Value
Environmental Conditions	Designed and intended for indoor use Altitudes of up to 2,000 m above Sea Level max. relative Humidity 80 % up to 31 °C; decreasing linearly up to 50 % relative Humidity at 40 °C.
Permissible Ambient Temperature during Operation	+2 °C to +35 °C
Permissible Ambient Temperature during Storage and Shipping	-10 °C to +50 °C
Overvoltage Category	II
Pollution Degree	2
Heat Dissipation	Ventilated 0,31 kWh/h / 1060 Btu/h / 1120 kJ/h
IP	20
Max Running Time	99 h 59 min 50 sec, hold
Max Speed $n_{\max}$	16000 rpm (depending on the rotor)
Min Speed $n_{\min}$	300 rpm
Max RCF Value at $n_{\max}$	24327xg
Maximum Kinetic Energy	8.12 < kJ
Noise Level at Maximum Speed	< 58 dB (A) TX-150 Rotor; < 61 MicroClick 24x2 Rotor
Dimensions	Ventilated
Height	310 mm
Height with Lid Open	660 mm
Width	370 mm
Depth	490 mm
Weight without Rotor	35 kg



## Directives, Standards and Guidelines

**Tabelle 1-2.** Directives, Standards and Guidelines

Tension / Frequency	Directive	Produced and inspected according to the following standards and guidelines
<b>Europe</b> 230V 50/60Hz	<ul style="list-style-type: none"> <li>• 2006/95/EC Low Voltage Directive</li> <li>• 2006/42/EC Machinery</li> <li>• 2004/108/EC Electromagnetic compatibility (emc)</li> <li>• 2011/65/EC RoHS Directive on the Restriction of the use of certain Hazardous Substances in electrical and electronic equipment.</li> <li>• 2002/96/EC WEEE: Directive on Waste Electrical and Electronic Equipment</li> <li>• 1907/2006 REACH Regulation on Registration, Evaluation, Authorization and Restriction of Chemicals (including requirements for SVHC, substances of very high concern)</li> </ul>	EN 61010-1, 2 <sup>nd</sup> Edition EN 61010-2-020, 2 <sup>nd</sup> Edition EN 61010-2-101, 2 <sup>nd</sup> Edition EN 61326-1 Class B EN 61326-2-6 EN ISO 13485
<b>USA &amp; Canada</b> 230V 60Hz 120V 60Hz	FDA Device Class 1 Product code JQC (centrifuges for clinical use)	CAN/CSA-C22.2 No. 61010-1-04 UL Std. No. 61010-1, 2nd Edition) CAN/CSA-C22.2 No. 61010-2-020-09-Part 2-020 IEC 61010-2-020, 2nd Edition IEC 61010-2-101, 2nd Edition EN ISO 13485
<b>Japan</b> 100V 60Hz 100V 50Hz		IEC 61010-1, 2 <sup>nd</sup> Edition IEC 61010-2-020, 2 <sup>nd</sup> Edition IEC 61010-2-101, 2 <sup>nd</sup> Edition
<b>China</b> 230V 50/60Hz		EN 61326-1 Class B EN 61326-2-6 EN ISO 13485

## Functions and Features

The following table gives an overview of the important functional and performance characteristics of the Thermo Scientific Sorvall ST 8 Centrifuge.

**Tabelle 1-3.** Functions and Features

Component / Function	Description / Features
Structure / Housing	Galvanized steel chassis with armoured plating
Chamber	Stainless steel
Drive	Induction drive without carbon brushes
Keys and display	Easy-to-clean keypad and display surface
Controls	Microprocessor-controlled
Internal memory	The most recent data is saved
Functions	RCF-selection
Acceleration / braking profiles	Standard and Soft Acceleration/Deceleration
Rotor recognition	Automatic / Electric
Imbalance recognition	Electronic, contingent on rotor and speed
Lid lock	Lid is locking, when being pressed down

## Mains Supply

The following table contains an overview of the electrical connection data for the Thermo Scientific Sorvall ST 8 Centrifuge. This data is to be taken into consideration when selecting the mains connection socket.

**Tabelle 1-4.** Electrical connection data of the Thermo Scientific Sorvall ST 8 Centrifuge

Cat.		Mains voltage ± 10 %	Frequency	Rated current	Power consumption	Equipment fuse	Building fuse
75007221	ventilated	230 V	50 / 60 Hz	2,0 A	310 W	5 AT	16 AT
75007220	ventilated	120 V	60 Hz	5,0 A	310 W	10 AT	15 AT

## Rotor Selection

The Thermo Scientific Sorvall ST 8 Centrifuge is supplied without a rotor.

Various rotors are available to choose from.

<b>Thermo Scientific Rotors</b>	<b>Part No.</b>
TX-150 swinging bucket rotor	75005701
TX-150 round buckets	75005702
TX-150 50mL conical buckets	75005703
TX100S clinical swinging bucket rotor with sealed carriers	75005704
TX100 clinical swinging bucket rotor with carriers	75005705
M10 microplate swinging bucket rotor	75005706
M10 with buckets	75005723
MT12 microtube swinging bucket rotor	75005600
HIGHConic III fixed angle rotor	75005709
CLINIConic fixed angle rotor	75003623
MicroClick 24x2 microtube rotor	75005715
MicroClick 30x2 microtube rotor	75005719
8x8 PCR Strip rotor	75005720
Hematocrit rotor	75005733

The technical data of the rotors and the corresponding adapters and reduction sleeves for various commercially available containers can be found in the corresponding rotor operating manuals.

For more information visit our website at: <http://www.thermoscientific.com>

## Before Use

### Contents

- “Before Setting up” on page 22
- “Transporting the Centrifuge” on page 23
- “Location” on page 22
- “Aligning the Centrifuge” on page 23
- “Mains Connection” on page 24
- “Storage” on page 24

## Before Setting up

1. Check the centrifuge and the packaging for any shipping damage.  
Inform the shipping company and Thermo Fisher Scientific immediately if any damage is discovered.
2. Remove the packaging.
3. Check the order for completeness (see “Items Supplied” on page 9).  
If the order is incomplete, please contact Thermo Fisher Scientific.

## Location

The centrifuge should only be operated indoors.

The set-up location must fulfil the following requirements:

- A safety zone of at least 30 cm must be maintained around the centrifuge.  
People and hazardous substances must be kept out of the safety zone while centrifuging.
- The supporting structure must be stable, free of resonance and plane, for example a laboratory bench.
- The supporting structure must be suitable for horizontal setup of the centrifuge.
- The centrifuge should not be exposed to heat.



**WARNING** UV rays reduce the stability of plastics.  
Do not subject the centrifuge, rotors and plastic accessories to UV rays like in direct sunlight.

- The set-up location must be well-ventilated at all times.

## Transporting the Centrifuge

- Due to its weight (see “Technical Data” on page 17), the centrifuge should be carried by several people.
- Always lift the centrifuge at both sides.



**Figure 1.** Lifting the centrifuge at both sides.

- Transport the centrifuge upright and if at all possible in its packaging.



**WARNING** Always lift the centrifuge on both sides. Never lift the centrifuge by its front or back panel.  
Always remove the rotor before moving the centrifuge.

**Note** Store the original centrifuge packaging. Contact a shipping company for the transport or inform the customer service.

Always remove the rotor before moving the centrifuge. If you do not remove the rotor you might damage the centrifuge drive or centrifuge spindle.

## Aligning the Centrifuge

The horizontal alignment of the centrifuge must be checked every time after moving it to a different location.

The supporting structure must be suitable for horizontal setup of the centrifuge.



**CAUTION** If the centrifuge isn't leveled, imbalances can occur and the centrifuge can be damaged.  
Do not place anything under the centrifuge feet to level the centrifuge.

## Mains Connection

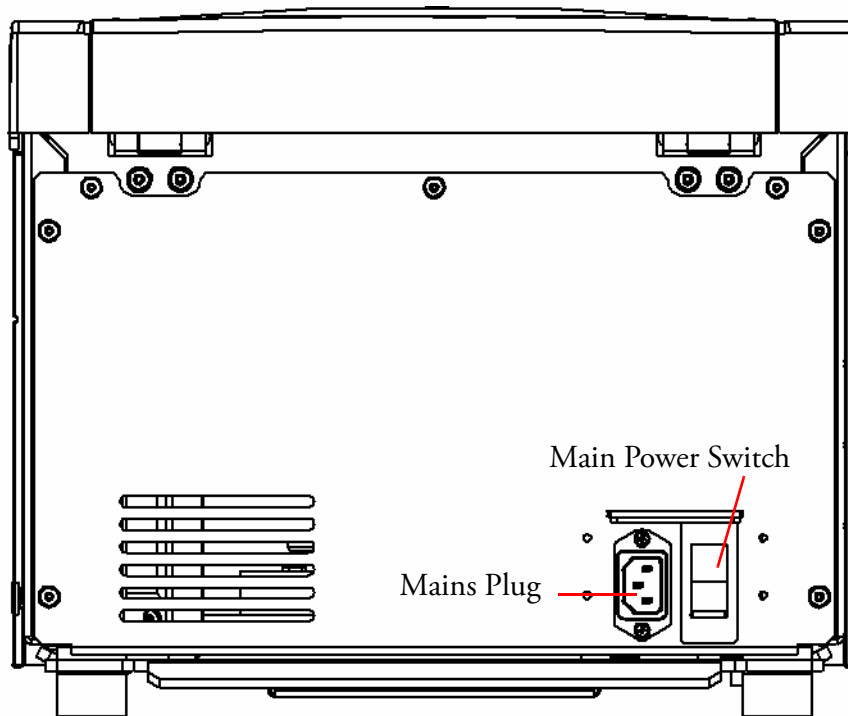

**Figure 2.** Mains Connection

1. Press Main Power Switch to ("0").
2. Plug the centrifuge into grounded electrical sockets only.
3. Check whether the cable complies with the safety standards of your country.
4. Make sure that the voltage and frequency correspond to the figures on the rating plate.
5. Establish the connection to the power supply with the connecting cable.

## Storage



**WARNING** When removing the centrifuge and accessories from use you have to clean and if necessary disinfect or decontaminate the entire system. In doubt contact the Thermo Fisher Scientific customer service.

- Before storing the centrifuge and the accessories, it must be cleaned, and if necessary, disinfected and decontaminated.
- Store the centrifuge in a clean, dust-free location.
- Be sure to place the centrifuge on their centrifuge feet.
- Avoid direct sunlight.

## Shipping the Centrifuge

Before shipping the centrifuge please bear the following in mind:

- The centrifuge must be clean and decontaminated.
- The decontamination must be confirmed in a special form.



**WARNING** Before shipping the centrifuge and accessories you have to clean and if necessary disinfect or decontaminate the entire system. In doubt contact the Thermo Fisher Scientific customer service.



## **2 Before Use**

Shipping the Centrifuge

# Control Panel

## Contents

- “Control Panel” on page 28
- “Keys” on page 28





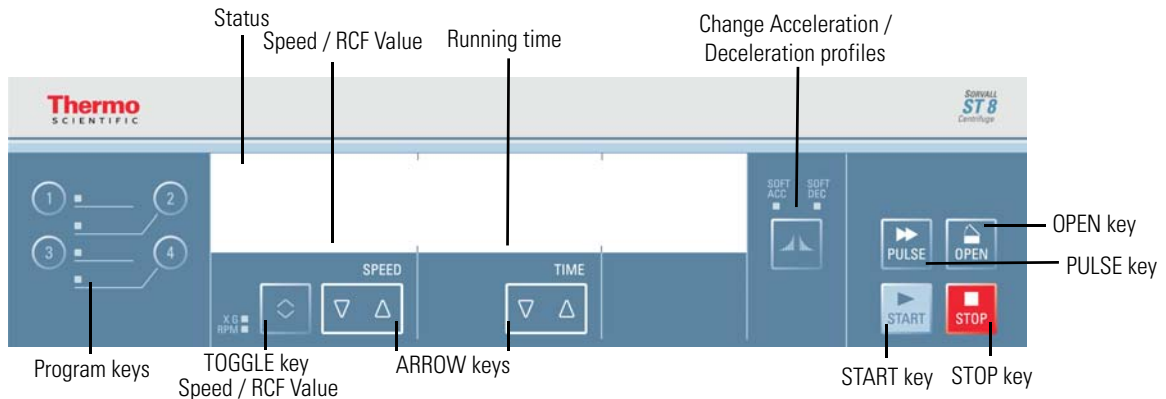

## Control Panel

The control panel contains the keys and displays of the centrifuge (only the power switch is located on the back of the device).



## Keys

The keys allow user input for controlling the operating mode as follows:

Key	Function	Display contents
	<b>Start</b>	Press the START key to start a centrifugation run or to accept the current settings.
	<b>Stop</b>	Press the STOP key to manually end the centrifugation run.
	<b>Open lid</b>	Press the OPEN key to activate the automatic release (possible only when device is switched on). Emergency release (see <a href="#">“Mechanical Emergency Door Release”</a> on page 54)
	<b>Pulse</b>	Press the PULSE key to immediately start the centrifugation run and accelerate up to the maximal permissible end speed (depending on the used rotor). Releasing the key initiates a stopping process at the highest braking curves.
	<b>Change Value</b>	Use the ARROW keys in order to modify the displayed value
	<b>Acceleration/Deceleration</b>	Press the ACCELERATION/DECCELERATION key multiple times to change the different profiles
	<b>Changing the display mode</b>	Use the TOGGLE key to change the display mode. (Speed / RCF Value)

# Operation

## Contents

- “Switch on Centrifuge” on page 30
- “Open Lid” on page 30
- “Close Lid” on page 30
- “Rotor Installation” on page 31
- “Entering Parameters” on page 32
- “Saving Programs” on page 34
- “Centrifugation” on page 35
- “Short-term Centrifugation” on page 37
- “Removing the Rotor” on page 37
- “Aligning the Centrifuge” on page 38

## Switch on Centrifuge

1. Turn on the power switch on the back of the device.  
The device performs a self-check of its software.
  - a. When the centrifuge lid is closed the following display shows:



The speed and time displays read 0.

- b. When the centrifuge lid is open the following display shows:

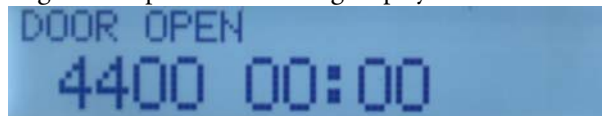

The speed and time displays show the pre-set values.

## Open Lid

1. Press the OPEN key.



**WARNING** Do not reach into the gap between the lid and the housing. Use the emergency release only for malfunctions and power failures (see “[Mechanical Emergency Door Release](#)” on [page 54](#)).

## Close Lid

Close the lid by pressing down on it lightly in the middle or on both sides of it.

**Note** The lid should audibly click into place.

## Rotor Installation

The approved rotors for the Thermo Scientific Sorvall ST 8 are listed in section “Rotor Selection” on page 20. Use only the rotors and accessories from this list in the centrifuge.



**CAUTION** Unapproved or incorrectly combined accessories can cause serious damage to the centrifuge.

The centrifuge is equipped with an Auto-Lock™ locking system.

This system is used to automatically lock the rotor to the centrifuge spindle. The rotor does not have to be bolted on to the centrifuge spindle.

Proceed as follows:

1. Open the lid of the centrifuge and if necessary remove any dust, foreign objects or residue from the chamber.  
Auto-Lock and O-Ring must be clean and undamaged.

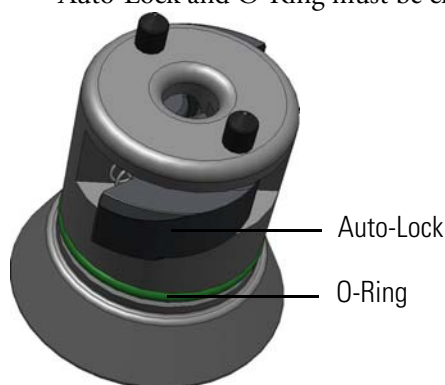

**Figure 3.** Auto-Lock

Place the rotor over the centrifuge spindle and let it slide slowly down the centrifuge spindle. The rotor clicks automatically into place.



**CAUTION** Do not force the rotor onto the centrifuge spindle. If the rotor is very light, then it may be necessary to press it onto the centrifuge spindle with a bit of pressure.

2. Check if the rotor is properly installed by lifting it slightly on the handle. If the rotor can be pulled up, then it must be reclamped to the centrifuge spindle.



**WARNING** If the rotor cannot be properly locked in place after several attempts, then the Auto-Lock is defective and you are not permitted to operate the rotor. Check for any damage to the rotor: Damaged rotors must not be used. Keep the centrifuge spindle area of the rotor clear of objects.



**CAUTION** Check that the rotor is properly locked on the centrifuge spindle before each use by pulling it at its handle. The rotor has to be locked tight.

3. If available close the rotor with the rotor lid.



Be sure to check all sealings before starting any aerosol-tight applications. See the information in the rotor instruction manual.

4. Close the centrifuge lid.

## Entering Parameters

The Thermo Scientific Sorvall ST 8 offers you 2 profiles: standard and soft. Press the ACCELERATION / DECELERATION key to set a profile. The LEDs show the chosen settings. The last profile is saved, if you restart the centrifuge.

Settings	Description
OFF	No Acceleration and Deceleration = Standard
SOFT ACC	Acceleration = Soft.
SOFT DEC	Deceleration = Soft
SOFT ACC/DEC	Acceleration and Deceleration = Soft

**Table 2.** Acceleration / Deceleration settings

### Pre-Selecting Speed / RCF

1. Press the TOGGLE key below the SPEED display in order to open the speed / RCF value menu. The two LED next to the small up and down key show the "RPM" or the "RCF"-value. Press the TOGGLE key to switch between the two modes.
2. Enter the desired value by holding the ARROW keys below SPEED in the corresponding direction, until the desired value shows.  
Press the START key to accept or wait until the centrifuge automatically saves the chosen values.

**Note** If an extremely low RCF value has been selected, it will be corrected automatically if the resulting speed is less than 300 rpm.

### Explanation of RCF Value

The relative centrifugal force is given as a multiple of the force of gravity  $g$ . It is a unitless numerical value which is used to compare the separation or sedimentation capacity of various devices, since it is independent of the type of device. Only the centrifuging radius and the speed come into play in it:

$$\text{RCF} = 11,18 \times \left\langle \frac{n}{1000} \right\rangle^2 \times r$$

$r$  = centrifuging radius in cm

$n$  = Rotational speed in rpm

The maximum RCF value is related to the maximum radius of the tube opening.

Remember that this value is reduced depending on the tubes and adapters used.

This can be accounted for in the calculation above if required.



### Running time pre-selection

1. Press the ARROW keys below TIME in order to open the runtime selection menu.  
Enter the desired runtime in hh:mm or mm:ss.

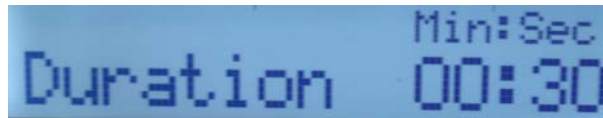

2. Enter the desired value by holding the ARROW keys below TIME in the corresponding direction, until the desired value shows.
3. Press the START key to accept or wait until the centrifuge automatically saves the chosen values.

### Continuous operation

1. Press the ARROW keys until HOLD shows.
2. Press the START key to accept or wait until the centrifuge automatically saves the chosen values.  
During continuous operation, the centrifuge will continue running until you stop it manually.

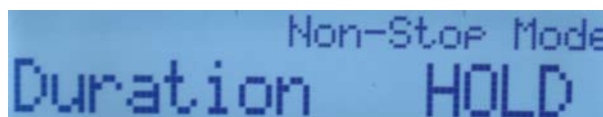

## Programs

The Thermo Scientific SL 8 Centrifuge is able to save up to 4 programs. It is only possible to save a program, if the centrifuge is not running.

### Saving Programs

1. Modify the speed and running time.
2. Press the program key for 4 seconds, you want to save the program with.
3. Enter a name for the program. There is place for 12 signs. Use the ARROW keys below SPEED for setting a number or a letter. Use the same key under TIME for switching right or left.
4. Press the START key to confirm and save the program.

To abort at any point, press the STOP key.

### Loading a Program

Press the program key, you want to load.

If you want to replace the loaded program with other settings, than change the values by pressing the ARROW keys below SPEED and TIME.

# Centrifugation

## Maximum Loading

The rotor can run at high speeds. The rotor design has sufficient reserve stability even when spinning at top speed.

The safety system of the centrifuge requires that you do not overload the rotor.



**WARNING** Injuries with fatal consequences can occur when using substance mixtures with a higher density at maximum speed than  $1.2 \frac{g}{cm^3}$ .

There are two options available for centrifuging samples whose weight, including adapter, exceeds the maximum permissible load:

- Reduce the fill level.
- Reduce the speed.

Use the table or the formula:

$$n_{adm} = n_{max} \sqrt{\frac{\text{Maximum permissible load}}{\text{Effective load}}}$$

$n_{adm}$  = admissible speed

$n_{max}$  = maximum speed

Once the rotor has been properly installed, the main switch turned on and the lid closed, you may start centrifuging.

## Starting the Centrifuge Run

Press the START key on the control panel. The centrifuge accelerates to the pre-set speed with the time display active.

If the speed setting is higher than the maximum permissible speed or RCF-value for the particular rotor, then the display will show the message „Limit [max. permitted value in rcf or xg]“ once the centrifuge has been started.

Within 10 seconds you can apply this value by pressing the START key again, and the centrifuging program will continue. Otherwise the centrifuge will stop and you will have to enter a valid number.

You cannot open the lid as long as the centrifuge is running.

## Imbalance Indicator

If a load is imbalanced, this will be indicated at speed higher than approx. 300 rpm by the message "Imbalanced load".

The run will terminate.

Check the loading and start the centrifuge once again. See the information on proper loading in the rotor instruction manual. For information on troubleshooting, see section “[Troubleshooting by Guide](#)” on [page 55](#).

## **Stopping the Centrifuge Run**

### **With pre-set running time**

If the running time is preset, you only have to wait until the centrifuge stops automatically when the preset time limit expires.

As soon as the speed drops to zero, the message RUN COMPLETED will appear in the display. By pressing the OPEN key, you can open the lid and remove the centrifuged samples.

You can also stop the centrifuging program manually at any time by pressing the STOP key.

### **Continuous operation**

If you selected continuous operation (see “[Continuous operation](#)” on [page 34](#)), you will have to stop the centrifuge manually. Press the STOP key on the control panel. The centrifuge will be decelerated at the designated rate. The message RUN COMPLETED will illuminate, and after pressing the OPEN key, the lid will open and you can remove the centrifuged samples.

## Short-term Centrifugation

For short-term centrifugation, the Thermo Scientific Sorvall ST 8 has a PULSE-function.

By holding down the PULSE key, spinning will start and continue until the key is let go.

The centrifuge accelerates and brakes at maximum power. Any rpm or RCF entered beforehand is overridden.

**Note** The centrifuge accelerates to maximum speed according to the rotor used.

Check carefully whether you have to maintain a certain speed for your application.

During the acceleration process, time is counted forwards in seconds. The reading stays displayed until the centrifuge lid is opened.

## Removing the Rotor

To remove the rotor, proceed as follows:

1. Open the centrifuge lid.
2. Grab the rotor handle and press against the green Auto-Lock button. At the same time, pull the rotor directly upwards and remove it from the centrifuge spindle. Make sure not to tilt the rotor while doing this.



## Aerosol-tight Rotors

When using an aerosol tight lid the rotor can only be removed with the lid closed. This is to protect you and the samples.



**CAUTION** Rotors supplied with a lid for aerosol-tight applications come with a mandrel, which belongs to the Auto-Lock. Be sure not to place the lid onto this mandrel to prevent it from being damaged.

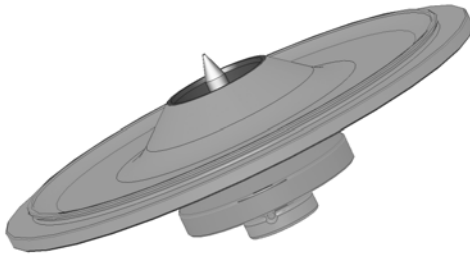

**Figure 4.** Auto-Lock-lid for aerosol-tight rotors



**WARNING** Mind the Auto-Lock-mandrel inside the lid. Do not touch the mandrel.

## Aligning the Centrifuge

- To turn off the centrifuge push the mains switch to "0".

## System Menu

To get into the system menu, press and hold any button when turning on the centrifuge until the system menu shows up in the display. Use the ARROW keys below the time selection in order to navigate within the system menu points.

## 5 System Menu

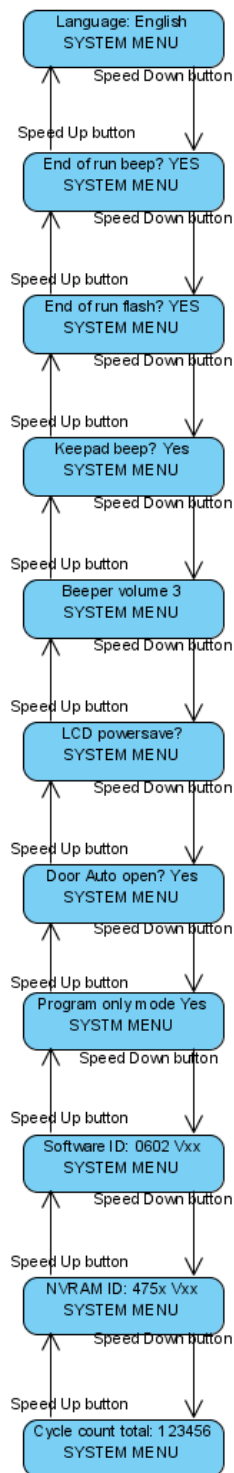

English  
 Nederlands  
 Русский  
 Français  
 Español  
 Italiano  
 Deutsch

0602 V01\*  
 4758 V05

\* Software and NVRAM identification example values.

## Description

### Enter system menu

To enter the system menu hold down any of the keys when switching the centrifuge on. Press the START key to enter the system menu.

Use the ARROW keys below SPEED in order to navigate through the system menu.

Use the ARROW keys below TIME selection in order to navigate within the system menu points.

Press the START key to save any edits and quit the system menu.

Press the STOP key to quit the system menu.

### Language

Use the ARROW keys below TIME in order to change the language in the display until the desired language appears in the display.

Use the ARROW keys below SPEED in order to navigate through the system menu.

Press the START key to save this edit and quit the system menu.

Press the STOP key to quit the system menu.

### End of run beep

Use the ARROW keys below TIME until it says YES in the display. The centrifuge beeps after the run. Otherwise use the ARROW keys below TIME until it says NO.

Use the ARROW keys below SPEED in order to navigate through the system menu.

Press the START key to save this edit and quit the system menu.

Press the STOP key to quit the system menu.

### End of run flash

Use the ARROW keys below TIME until it says YES in the display. The centrifuge flashes after the run. Otherwise use the ARROW keys below TIME until it says NO.

Use the ARROW keys below SPEED in order to navigate through the system menu.

Press the START key to save this edit and quit the system menu.

Press the STOP key to quit the system menu.



### **Keypad beep**

Use the ARROW keys below TIME until it says YES in the display. The centrifuge beeps when pressing any key. Otherwise use the ARROW keys below TIME until it says NO.

Use the ARROW keys below SPEED in order to navigate through the system menu.

Press the START key to save this edit and quit the system menu.

Press the STOP key to quit the system menu.

### **Beeper volume**

Use the ARROW keys below TIME to set the desired volume. The volume can be set from 0 (silent) to 5 (loudest).

Use the ARROW keys below SPEED in order to navigate through the system menu.

Press the START key to save this edit and quit the system menu.

Press the STOP key to quit the system menu.

### **LCD powersave**

Use the ARROW keys below TIME until it says YES in the display. The centrifuge enters a powersave mode after the run. Otherwise use the ARROW keys below TIME until it says NO.

Use the ARROW keys below the speed display in order to navigate through the system menu.

Press the START key to save this edit and quit the system menu.

Press the STOP key to quit the system menu.

### **Door auto-open**

Use the ARROW keys below TIME until it says YES in the display. The centrifuge opens the door automatically after the run. Otherwise use the ARROW keys below TIME until it says NO.

Use the ARROW keys below SPEED display in order to navigate through the system menu.

Press the START key to save this edit and quit the system menu.

Press the STOP key to quit the system menu.

### **Program only mode**

Use the ARROW keys below TIME until it says YES in the display. The centrifuge only runs with programs. No manual input is possible. Otherwise use the ARROW keys below TIME until it says NO.

Use the ARROW keys below the speed display in order to navigate through the system menu.

Press the START key to save this edit and quit the system menu.

Press the STOP key to quit the system menu.

### **Software ID**

Here you find the current software version.

Use the ARROW keys below SPEED in order to navigate through the system menu.

Press the STOP key to quit the system menu.

### **NVRAM ID**

Here you find the current software version.

Use the ARROW keys below SPEED in order to navigate through the system menu.

Press the STOP key to quit the system menu.

### **Cycle count**

Here you find the current numbers of cycles.

Use the ARROW keys below SPEED in order to navigate through the system menu.

Press the START key to save this edit and quit the system menu.

Press the STOP key to quit the system menu.

## 5 System Menu

Description

## Maintenance and Care

### Contents

- “Cleaning Intervals” on page 46
- “Cleaning” on page 46
- “Disinfection” on page 48
- “Decontamination” on page 49
- “Autoclaving” on page 50
- “Thermo Fisher Scientific Service” on page 50

## Cleaning Intervals

For the sake of personal, environmental, and material protection, it is your duty to clean and if necessary disinfect the centrifuge on a regular basis.

Maintenance	Recommended interval
Clean rotor chamber	Daily or when polluted
Clean rotor	Daily or when polluted
Accessories	Daily or when polluted
Cabinet	Once per month
Ventilation holes	Every six months



**CAUTION** Refrain from using any other cleaning or decontamination procedure than those recommended.

Use only approved cleansers.

If in doubt, contact Thermo Fisher Scientific.

## Cleaning

When cleaning the centrifuge:

- Use warm water with a neutral solvent.
- Never use caustic cleaning agents such as soap suds, phosphoric acid, bleaching solutions or scrubbing powder.
- Rinse the cavities out thoroughly.
- Use a soft brush without metal bristles to remove stubborn residue.
- Afterwards rinse with distilled water.
- Place the rotors on a plastic grate with their cavities pointing down.
- If drying boxes are used, the temperature must never exceed 50 °C, since higher temperatures could damage the material and shorten the lifetime of the parts.
- Use only disinfectants with a pH of 6-8.
- Dry aluminum parts off with a soft cloth.
- After cleaning, treat the entire surface of aluminum parts with corrosion protection oil (part no. 70009824). Also treat the cavities with oil.
- Store the aluminum parts at room temperature or in a cold-storage room with the cavities pointing down.



**CAUTION** Before using any cleaning or decontamination methods except those recommended by the manufacturer, users should check with the manufacturer that the proposed method will not damage the equipment.

Clean centrifuge and accessories as follows:

1. Open the centrifuge.
  2. Turn off the centrifuge.
  3. Pull out the power supply plug.
  4. Grasp the rotor with both hands and lift it vertically off the centrifuge spindle.
  5. Remove the centrifuge tubes and adaptors.
  6. Use a neutral cleaning agent with a pH value between 6 and 8 for cleaning.
  7. Dry all of the rotors and accessories after cleaning with a cloth or in a warm air cabinet at a maximum temperature of 50 °C.
- After cleaning, treat the entire surface of aluminum parts with corrosion protection oil (part no. 70009824). Also treat the cavities with oil.
  - Treat the bolt of the swing out rotor with bolt grease (part no. 75003786).



**CAUTION** When cleaning, do not allow liquids, especially organic solvents, to get on the drive shaft or the bearings of the centrifuge. Organic solvents break down the grease in the motor bearing. The drive shaft could lock up.

## Disinfection

Disinfect the centrifuge immediately if infectious material has spilled during centrifugation.



**WARNING** Infectious material can get into the centrifuge when a tube breaks or as a result of spills. Keep in mind the risk of infection when touching the rotor and take all necessary precautions.

In case of contamination, make sure that others are not put at risk.  
Decontaminate the affected parts immediately.  
Take other precautions if need be.

The rotor chamber and the rotor should be treated preferably with a neutral disinfectant.



**CAUTION** Before using any cleaning or decontamination methods except those recommended by the manufacturer, users should check with the manufacturer that the proposed method will not damage the equipment.

Observe the safety precautions and handling instructions for the cleaning agents used.

Contact the Service Department of Thermo Fisher Scientific for questions regarding the use of other disinfectants.

Disinfect the rotor and accessories as follows:

1. Open the centrifuge.
2. Turn off the centrifuge.
3. Pull out the power supply plug.
4. Grasp the rotor with both hands and lift it vertically off the centrifuge spindle.
5. Remove the centrifuge tubes and adapters and dispose of them or disinfect them.
6. Treat the rotor and accessories according to the instructions for the disinfectant (soak in solution). Adhere strictly to the given application times.
7. Be sure the disinfectant can drain off the rotor.
8. Rinse the rotor and accessories thoroughly with water.
9. Dispose of the disinfectant according to the applicable guidelines.
10. Dry all of the rotors and accessories after cleaning with a cloth or in a warm air cabinet at a maximum temperature of 50 °C.
  - After cleaning, treat the entire surface of aluminum parts with corrosion protection oil (part no. 70009824). Also treat the cavities with oil.
  - Tread the bolt of the swing out rotor with bolt grease (part no. 75003786).

## Decontamination

Decontaminate the centrifuge immediately whenever radioactive material has spilled during centrifugation.



**WARNING** Radioactive material can get into the centrifuge when a tube breaks or as a result of spills. Keep in mind the risk of infection when touching the rotor and take all necessary precautions.  
In case of contamination, make sure that others are not put at risk.  
Decontaminate the affected parts immediately.  
Take other precautions if need be.



**CAUTION** Before using any cleaning or decontamination methods except those recommended by the manufacturer, users should check with the manufacturer that the proposed method will not damage the equipment.

For general radioactive decontamination use a solution of equal parts of 70% ethanol, 10% SDS and water.

1. Open the centrifuge.
2. Turn off the centrifuge.
3. Pull out the power supply plug.
4. Grasp the rotor with both hands and lift it vertically off the centrifuge spindle.
5. Remove the centrifuge tubes and adaptors and dispose of them or disinfect them.
6. Rinse the rotor first with ethanol and then with de-ionized water.  
Adhere strictly to the given application times.
7. Be sure the decontamination solution can drain off the rotor.
8. Rinse the rotor and accessories thoroughly with water.
9. Dispose of the decontamination solution according to the applicable guidelines.
10. Dry all of the rotors and accessories after cleaning with a cloth or in a warm air cabinet at a maximum temperature of 50 °C.
  - After cleaning, treat the entire surface of aluminum parts with corrosion protection oil (part no. 7000 9824). Also treat the cavities with oil.
  - Treat the bolt of the swing out rotor with bolt grease (part no. 75003786).



## Autoclaving

1. Before autoclaving clean rotor and accessories and described above.
2. Place the rotor on a flat surface.
  - Rotors and adapter can be autoclaved at 121 °C.
  - The maximum permissible autoclave cycle is 20 minutes at 121 °C.

**Note** No chemical additives are permitted in the steam.



**CAUTION** Never exceed the permitted temperature and duration when autoclaving. If the rotor shows signs of corrosion or wear, it must be replaced.

## Thermo Fisher Scientific Service

Thermo Fisher Scientific recommends having the centrifuge and accessories serviced once a year by an authorized service technician. The service technicians check the following:

- the electrical equipment
- the suitability of the set-up site
- the lid lock and the safety system
- the rotor
- the fixation of the rotor and the drive shaft
- the protective casing

Thermo Fisher Scientific offers inspection and service contracts for this work. Any necessary repairs are performed for free during the warranty period and afterwards for a charge.

This is only valid if the centrifuge has only been maintained by a Thermo Fisher Scientific service technician.

## Disposal



**WARNING** When removing the centrifuge and accessories from use for disposal you have to clean and if necessary disinfect or decontaminate the entire system. In doubt contact the Thermo Fisher Scientific customer service.

For the disposal of the centrifuge mind the regulations in your country. In doubt contact the Thermo Fisher Scientific Customer Service for the disposal of the centrifuge.

For the countries of the European Union the disposal is regulated by the European Union's Waste Electrical & Electronic Equipment (WEEE) Directive 2002/96/EC. See [“WEEE Compliance”](#) on [page 5](#)

Mind the information on transport and shipping. See [“Transporting the Centrifuge”](#) on [page 23](#) and [“Shipping the Centrifuge”](#) on [page 25](#) for more information.



# Troubleshooting

## Contents

- “Mechanical Emergency Door Release” on page 54
- “Troubleshooting by Guide” on page 55
- “When to Contact Customer Service” on page 57

## Mechanical Emergency Door Release

During a power failure, you will not be able to open the centrifuge lid with the regular electric lid release. A mechanical override is provided to allow sample recovery in the case of an emergency. However, this should be used only in emergencies and after the rotor has come to a complete stop.



**WARNING** The rotor can still be spinning at high speed. If touched, it can cause serious injuries.

Always wait 20 minutes until the rotor has come to a stop without braking. The brake does not work when there is no current. The braking process lasts much longer than usual.

Proceed as follows:

1. Make sure the rotor has stopped (view port in the lid).



**WARNING** Never use your hand or other tools to brake the rotor.

2. Pull out the power supply plug.
3. On the right side of the housing is one white plastic plug which you can pry out of the side plate with a screwdriver.  
Pull the release cord attached to it to trigger the mechanical door release. The door will open and the samples can be removed.

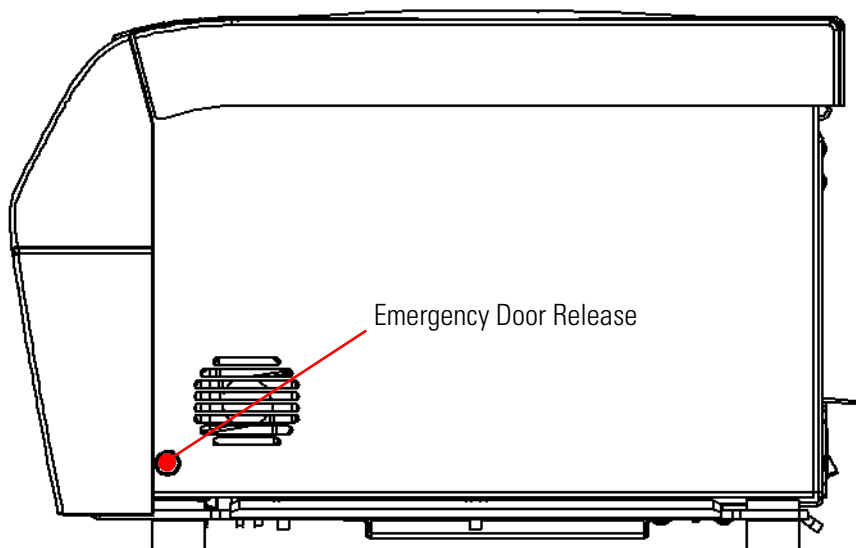

**Figure 5.** Emergency Door Release

4. Push the cord back into the centrifuge and mount the plug.

Reconnect the centrifuge once the power has been restored. Switch on the centrifuge. Press the OPEN key to have the door locks operative again.

## Troubleshooting by Guide

If other problems occur than those listed in this table, the customer service has to be contacted.

Error number	Error message	Troubleshooting
E-002; E-005; E-008; E-010; E-011; E-012; E-015; E-016; E-034; E-036; E-041; E-048; E-050; E-051; E-052; E-053; E-054; E-072; E-077; E-101; E-104	Read Manual	Restart the centrifuge. If the error message appears again, inform the customer service.
E-031	Temp High!	<b>CAUTION</b> Hot metal parts! Check, if the centrifuge is accessible. Be sure, that the room temperature is within the limits. Let the centrifuge cool down for 15 minutes. If the error message appears again, inform the customer service.
E-017; E-020; E-021; E-022; E-023 E-078; E-079; E-080; E-081;	Read Manual	Wait until the rotor has stopped. Check, if the rotor is qualified for the Sorvall ST 8 Centrifuge (check <a href="#">"Rotor Selection"</a> on page 20). Check, if the bottom of the rotor is damaged and if the rotor is placed on the Auto-Lock correctly. If the error message appears again, inform the customer service.
E-019	Rotor Unknown	Restart the centrifuge. Check, if the rotor is qualified for the Sorvall ST 8 Centrifuge (check <a href="#">"Rotor Selection"</a> on page 20). If the error message appears again, inform the customer service.

Error number	Error message	Troubleshooting
E-025; E-027	Read Manual	Check, if the centrifuge lid is blocked. Restart the centrifuge. If the error message appears again, inform the customer service.
E-029; E-045	Read Manual	Check, if a rotor is installed. Check, if the rotor is qualified for the Sorvall ST 8 Centrifuge (check " <a href="#">Rotor Selection</a> " on <a href="#">page 20</a> ). Restart the centrifuge. If the error message appears again, inform the customer service.
E-030	Power Failure	Check the power supply of the centrifuge. Make sure not to operate too many devices at one power source. Let the centrifuge cool down for 15 minutes. If the error message appears again, inform the customer service.
E-098	Imbalance Load	Check the load placed in the rotor. Check that the rotor cross bolts are greased well. Restart the centrifuge. If the error message appears again, inform the customer service.
E-060	Temp Low!	<b>CAUTION</b> Icy metal parts! Restart the centrifuge. If the error message appears again, inform the customer service.
E-046	Door Open!	Restart the centrifuge. If the error message appears again, inform the customer service.

## When to Contact Customer Service

If you need to contact customer service, please provide the order no. and the serial no. of your centrifuge. This information can be found on the back near the inlet for the power supply cable.

In addition the customer service also needs the Software ID and the NVRAM ID. Both are available in the system menu. For a description how to get there, see [“Enter system menu”](#) on [page 41](#). You will find a description on how to find the [“Software ID”](#) on [page 43](#) and for the [“NVRAM ID”](#) on [page 43](#).





# Chemical Compatibility Chart

CHEMICAL	MATERIAL	ALUMINUM	ANODIC COATING for ALUMINIUM	BUNA N	CELLULOSE ACETATE BUTYRATE	POLYURETHANE ROTOR PAINT	COMPOSITE Carbon Fiber/Epoxy	DELRIN™	ETHYLENE PROPYLENE	GLASS	NEOPRENE	NORLYL™	NYLON	PET™, POLYCLEAR™, CLEARCRIMP™, CCLLEARCRIMP™	POLYALLOMER	POLYCARBONATE	POLYESTER, GLASS THERMOSET	POLYETHERIMIDE	POLYETHYLENE	POLYPROPYLENE	POLYSULFONE	POLYVINYL CHLORIDE	RULON A™, TEFLON™	SILICONE RUBBER	STAINLESS STEEL	TITANIUM	TYGON™	VITON™
2-mercaptoethanol	S	S	U	-	S	M	S	-	S	U	S	S	U	S	S	-	S	S	S	S	U	S	S	S	S	S	S	S
Acetaldehyde	S	-	U	U	-	-	-	M	-	U	-	-	-	M	U	U	U	M	M	-	M	S	U	-	S	-	U	
Acetone	M	S	U	U	S	U	M	S	S	U	U	S	U	S	U	U	U	S	S	U	U	S	M	M	S	U	U	
Acetonitrile	S	S	U	-	S	M	S	-	S	S	U	S	U	M	U	U	-	S	M	U	U	S	S	S	S	U	U	
Alconox™	U	U	S	-	S	S	S	-	S	S	S	S	S	S	M	S	S	S	S	S	S	S	S	S	S	S	S	U
Allyl Alcohol	-	-	-	U	-	-	S	-	-	-	-	S	-	S	S	M	S	S	S	S	-	M	S	-	-	S	-	-
Aluminum Chloride	U	U	S	S	S	S	U	S	S	S	S	M	S	S	S	S	-	S	S	S	S	S	M	U	U	S	S	
Formic Acid (100%)	-	S	M	U	-	-	U	-	-	-	-	U	-	S	M	U	U	S	S	-	U	S	-	U	S	-	U	
Ammonium Acetate	S	S	U	-	S	S	S	-	S	S	S	S	S	S	S	U	-	S	S	S	S	S	S	S	S	S	S	S
Ammonium Carbonate	M	S	U	S	S	S	S	S	S	S	S	S	S	S	U	U	-	S	S	S	S	S	S	M	S	S	S	
Ammonium Hydroxide (10%)	U	U	S	U	S	S	M	S	S	S	S	S	-	S	U	M	S	S	S	S	S	S	S	S	S	S	M	S
Ammonium Hydroxide (28%)	U	U	S	U	S	U	M	S	S	S	S	S	U	S	U	M	S	S	S	S	S	S	S	S	S	S	M	S
Ammonium Hydroxide (conc.)	U	U	U	U	S	U	M	S	-	S	-	S	U	S	U	U	S	S	S	-	M	S	S	S	S	-	U	
Ammonium Phosphate	U	-	S	-	S	S	S	S	S	S	S	S	-	S	S	M	-	S	S	S	S	S	S	M	S	S	S	
Ammonium Sulfate	U	M	S	-	S	S	U	S	S	S	S	S	S	S	S	S	-	S	S	S	S	S	S	U	S	S	U	
Amyl Alcohol	S	-	M	U	-	-	S	S	-	M	-	S	-	M	S	S	S	S	M	-	-	-	U	-	S	-	M	
Aniline	S	S	U	U	S	U	S	M	S	U	U	U	U	U	U	U	-	S	M	U	U	S	S	S	S	U	S	
Sodium Hydroxide (<1%)	U	-	M	S	S	S	-	-	S	M	S	S	-	S	M	M	S	S	S	S	S	S	M	S	S	-	U	
Sodium Hydroxide (10%)	U	-	M	U	-	-	U	-	M	M	S	S	U	S	U	U	S	S	S	S	S	S	M	S	S	-	U	
Barium Salts	M	U	S	-	S	S	S	S	S	S	S	S	S	S	S	M	-	S	S	S	S	S	M	S	S	S	S	
Benzene	S	S	U	U	S	U	M	U	S	U	U	S	U	U	U	M	U	M	U	U	U	S	U	U	S	U	S	
Benzyl Alcohol	S	-	U	U	-	-	M	M	-	M	-	S	U	U	U	U	U	U	U	-	M	S	M	-	S	-	S	

## 9 Chemical Compatibility Chart

CHEMICAL	MATERIAL																										
	ALUMINUM	ANODIC COATING for ALUMINIUM	BUNA N	CELLULOSE ACETATE BUTYRATE	POLYURETHANE ROTOR PAINT	COMPOSITE Carbon Fiber/Epoxy	DELRIN™	ETHYLENE PROPYLENE	GLASS	NEOPRENE	NORYL™	NYLON	PET*, POLYCLEAR™, CLEARCRIMP™, CCLLEARCRIMP™	POLYALLUMER	POLYCARBONATE	POLYESTER, GLASS THERMOSET	POLYETHERIMIDE	POLYETHYLENE	POLYPROPYLENE	POLYSULFONE	POLYVINYL CHLORIDE	RULON A™, TERLON™	SILICONE RUBBER	STAINLESS STEEL	TITANIUM	TYGON™	VITON™
Boric Acid	U	S	S	M	S	S	U	S	S	S	S	S	S	S	S	S	U	S	S	S	S	S	S	S	S	S	S
Cesium Acetate	M	-	S	-	S	S	S	-	S	S	S	S	-	S	S	-	-	S	S	S	S	S	S	M	S	S	S
Cesium Bromide	M	S	S	-	S	S	S	-	S	S	S	S	S	S	S	-	-	S	S	S	S	S	S	M	S	S	S
Cesium Chloride	M	S	S	U	S	S	S	-	S	S	S	S	S	S	S	-	-	S	S	S	S	S	M	S	S	S	
Cesium Formate	M	S	S	-	S	S	S	-	S	S	S	S	S	S	S	-	-	S	S	S	S	S	M	S	S	S	
Cesium Iodide	M	S	S	-	S	S	S	-	S	S	S	S	S	S	S	-	-	S	S	S	S	S	M	S	S	S	
Cesium Sulfate	M	S	S	-	S	S	S	-	S	S	S	S	S	S	S	-	-	S	S	S	S	S	M	S	S	S	
Chloroform	U	U	U	U	S	S	M	U	S	U	U	M	U	M	U	U	U	M	M	U	U	S	U	U	U	M	S
Chromic Acid (10%)	U	-	U	U	S	U	U	-	S	S	S	U	S	S	M	U	M	S	S	U	M	S	M	U	S	S	S
Chromic Acid (50%)	U	-	U	U	-	U	U	-	-	-	S	U	U	S	M	U	M	S	S	U	M	S	-	U	M	-	S
Cresol Mixture	S	S	U	-	-	-	S	-	S	U	U	U	U	U	U	-	-	U	U	-	U	S	S	S	S	U	S
Cyclohexane	S	S	S	-	S	S	S	U	S	U	S	S	U	U	U	M	S	M	U	M	M	S	U	M	M	U	S
Deoxycholate	S	S	S	-	S	S	S	-	S	S	S	S	S	S	S	-	-	S	S	S	S	S	S	S	S	S	S
Distilled Water	S	S	S	S	S	S	S	S	S	S	S	S	S	S	S	S	S	S	S	S	S	S	S	S	S	S	S
Dextran	M	S	S	S	S	S	S	-	S	S	S	S	S	S	S	S	S	S	S	S	S	S	M	S	S	S	S
Diethyl Ether	S	S	U	U	S	S	S	U	S	U	U	S	U	U	U	U	U	U	U	U	U	S	S	S	S	M	U
Diethyl Ketone	S	-	U	U	-	-	M	-	S	U	-	S	-	M	U	U	U	M	M	-	U	S	-	-	S	U	U
Diethylpyrocarbonate	S	S	U	-	S	S	S	-	S	S	U	S	U	S	U	-	-	S	S	S	M	S	S	S	S	S	S
Dimethylsulfoxide	S	S	U	U	S	S	S	-	S	U	S	S	U	S	U	U	-	S	S	U	U	S	S	S	S	U	U
Dioxane	M	S	U	U	S	S	M	M	S	U	U	S	U	M	U	U	-	M	M	M	U	S	S	S	S	U	U
Ferric Chloride	U	U	S	-	-	-	M	S	-	M	-	S	-	S	-	-	-	S	S	-	-	-	M	U	S	-	S
Acetic Acid (Glacial)	S	S	U	U	S	S	U	M	S	U	S	U	U	U	U	U	M	S	U	M	U	S	U	U	S	-	U
Acetic Acid (5%)	S	S	M	S	S	S	M	S	S	S	S	S	M	S	S	S	S	S	S	M	S	S	M	S	S	M	M
Acetic Acid (60%)	S	S	U	U	S	S	U	-	S	M	S	U	U	M	U	S	M	S	M	S	M	S	M	U	S	M	U
Ethyl Acetate	M	M	U	U	S	S	M	M	S	S	U	S	U	M	U	U	-	S	S	U	U	S	M	M	S	U	U
Ethyl Alcohol (50%)	S	S	S	S	S	S	M	S	S	S	S	S	U	S	U	S	S	S	S	S	S	S	S	M	S	M	U
Ethyl Alcohol (95%)	S	S	S	U	S	S	M	S	S	S	S	S	U	S	U	-	S	S	S	M	S	S	S	U	S	M	U
Ethylene Dichloride	S	-	U	U	-	-	S	M	-	U	U	S	U	U	U	U	U	U	U	-	U	S	U	-	S	-	S
Ethylene Glycol	S	S	S	S	S	S	S	S	S	S	S	S	-	S	U	S	S	S	S	S	S	S	S	M	S	M	S
Ethylene Oxide Vapor	S	-	U	-	-	U	-	-	S	U	-	S	-	S	M	-	-	S	S	S	U	S	U	S	S	S	U

CHEMICAL	ALUMINUM		ANODIC COATING for ALUMINIUM		BUNA N	CELLULOSE ACETATE BUTYRATE	POLYURETHANE ROTOR PAINT	COMPOSITE Carbon Fiber/Epoxy	DELRIN™	ETHYLENE PROPYLENE	GLASS	NEOPRENE	NORYL™	NYLON	PET*, POLYCLEAR™, CLEARCRIMP™, CCLLEARCRIMP™	POLYALLUMER	POLYCARBONATE	POLYESTER, GLASS THERMOSET	POLYETHERIMIDE	POLYETHYLENE	POLYPROPYLENE	POLYSULFONE	POLYVINYL CHLORIDE	RULON A™, TEFLON™	SILICONE RUBBER	STAINLESS STEEL	TITANIUM	TYGON™	VITON™
Ficoll-Hypaque™	M	S	S	-	S	S	S	-	S	S	S	S	S	-	S	S	-	S	S	S	S	S	S	S	M	S	S	S	
Hydrofluoric Acid (10%)	U	U	U	M	-	-	U	-	-	U	U	S	-	S	M	U	S	S	S	S	S	M	S	U	U	U	-	-	
Hydrofluoric Acid (50%)	U	U	U	U	-	-	U	-	-	U	U	U	U	S	U	U	U	S	S	M	M	S	U	U	U	-	M		
Hydrochloric Acid (conc.)	U	U	U	U	-	U	U	M	-	U	M	U	U	M	U	U	U	-	S	-	U	S	U	U	U	-	-		
Formaldehyde (40%)	M	M	M	S	S	S	S	M	S	S	S	S	M	S	S	S	U	S	S	M	S	S	S	M	S	M	U		
Glutaraldehyde	S	S	S	S	-	-	S	-	S	S	S	S	S	S	S	S	-	-	S	S	S	-	-	S	S	S	-	-	
Glycerol	M	S	S	-	S	S	S	S	S	S	S	S	S	S	S	S	S	-	S	S	S	S	S	S	S	S	S	S	
Guanidine Hydrochloride	U	U	S	-	S	S	S	-	S	S	S	S	S	S	S	S	-	-	S	S	S	S	S	S	U	S	S	S	
Haemo-Sol™	S	S	S	-	-	-	S	-	S	S	S	S	S	S	S	S	-	-	S	S	S	S	S	S	S	S	S	S	
Hexane	S	S	S	-	S	S	S	-	S	S	U	S	U	M	U	S	S	U	S	S	M	S	U	S	S	U	S		
Isobutyl Alcohol	-	-	M	U	-	-	S	S	-	U	-	S	U	S	S	M	S	S	S	-	S	S	S	-	S	-	S		
Isopropyl Alcohol	M	M	M	U	S	S	S	S	S	U	S	S	U	S	U	M	S	S	S	S	S	S	S	S	M	M	M	S	
Iodoacetic Acid	S	S	M	-	S	S	S	-	S	M	S	S	M	S	S	-	M	S	S	S	S	S	S	M	S	S	M	M	
Potassium Bromide	U	S	S	-	S	S	S	-	S	S	S	S	S	S	S	S	S	S	S	-	S	S	S	M	S	S	S		
Potassium Carbonate	M	U	S	S	S	S	S	-	S	S	S	S	S	S	U	S	S	S	S	S	S	S	S	S	S	S	S	S	
Potassium Chloride	U	S	S	-	S	S	S	S	S	S	S	S	S	S	S	-	S	S	S	S	S	S	S	S	U	S	S	S	
Potassium Hydroxide (5%)	U	U	S	S	S	S	M	-	S	S	S	S	-	S	U	S	S	S	S	S	S	S	S	M	U	M	S	U	
Potassium Hydroxide (conc.)	U	U	M	U	-	-	M	-	M	S	S	-	U	M	U	U	U	S	M	-	M	U	-	U	U	-	U		
Potassium Permanganate	S	S	S	-	S	S	S	-	S	S	S	U	S	S	S	M	-	S	M	S	U	S	S	M	S	U	S		
Calcium Chloride	M	U	S	S	S	S	S	S	S	S	S	S	S	S	M	S	-	S	S	S	S	S	S	M	S	S	S	S	
Calcium Hypochlorite	M	-	U	-	S	M	M	S	-	M	-	S	-	S	M	S	-	S	S	S	M	S	M	U	S	-	S		
Kerosene	S	S	S	-	S	S	S	U	S	M	U	S	U	M	M	S	-	M	M	M	S	S	U	S	S	U	S		
Sodium Chloride (10%)	S	-	S	S	S	S	S	S	-	-	-	S	S	S	S	S	-	S	S	S	S	-	S	S	M	-	S		
Sodium Chloride (sat'd)	U	-	S	U	S	S	S	-	-	-	-	S	S	S	S	-	S	S	-	S	-	S	-	S	S	M	-	S	
Carbon Tetrachloride	U	U	M	S	S	U	M	U	S	U	U	S	U	M	U	S	S	M	M	S	M	M	M	M	U	S	S		
Aqua Regia	U	-	U	U	-	-	U	-	-	-	-	-	U	U	U	U	U	U	U	-	-	-	-	-	-	S	-	M	
Solution 555 (20%)	S	S	S	-	-	-	S	-	S	S	S	S	S	S	S	-	-	S	S	S	-	S	S	S	S	S	S	S	
Magnesium Chloride	M	S	S	-	S	S	S	S	S	S	S	S	S	S	S	S	S	S	S	S	S	S	S	S	M	S	S	S	
Mercaptoacetic Acid	U	S	U	-	S	M	S	-	S	M	S	U	U	U	U	-	S	U	U	S	M	S	U	S	S	S	S		
Methyl Alcohol	S	S	S	U	S	S	M	S	S	S	S	S	U	S	U	M	S	S	S	S	S	S	S	M	S	M	U		

## 9 Chemical Compatibility Chart

CHEMICAL	MATERIAL	ALUMINUM	ANODIC COATING for ALUMINIUM	BUNA N	CELLULOSE ACETATE BUTYRATE	POLYURETHANE ROTOR PAINT	COMPOSITE Carbon Fiber/Epoxy	DELIRIN™	ETHYLENE PROPYLENE	GLASS	NEOPRENE	NORYL™	NYLON	PET*, POLYCLEAR™, CLEARCRIMP™, CCCCLEARCRIMP™	POLYALLUMER	POLYCARBONATE	POLYESTER, GLASS THERMOSET	POLYETHERIMIDE	POLYETHYLENE	POLYPROPYLENE	POLYSULFONE	POLYVINYL CHLORIDE	RULON A™, TERLON™	SILICONE RUBBER	STAINLESS STEEL	TITANIUM	TYGON™	VITON™
Methylene Chloride	U	U	U	U	M	S	S	U	S	U	U	S	U	U	U	U	U	U	M	U	U	U	S	S	M	U	S	U
Methyl Ethyl Ketone	S	S	U	U	S	S	M	S	S	U	U	S	U	S	U	U	U	U	S	S	U	U	S	S	S	S	U	U
Metrizamide™	M	S	S	-	S	S	S	-	S	S	S	S	-	S	S	-	-	S	S	S	S	S	S	S	M	S	S	S
Lactic Acid (100%)	-	-	S	-	-	-	-	-	-	M	S	U	-	S	S	S	M	S	S	-	M	S	M	S	S	-	S	
Lactic Acid (20%)	-	-	S	S	-	-	-	-	-	M	S	M	-	S	S	S	S	S	S	S	S	M	S	M	S	S	-	S
N-Butyl Alcohol	S	-	S	U	-	-	S	-	-	S	M	-	U	S	M	S	S	S	S	S	M	M	S	M	-	S	-	S
N-Butyl Phthalate	S	S	U	-	S	S	S	-	S	U	U	S	U	U	U	M	-	U	U	S	U	S	M	M	S	U	S	
N, N-Dimethylformamide	S	S	S	U	S	M	S	-	S	S	U	S	U	S	U	U	-	S	S	U	U	S	M	S	S	S	U	
Sodium Borate	M	S	S	S	S	S	S	S	S	S	S	U	S	S	S	S	-	S	S	S	S	S	S	M	S	S	S	
Sodium Bromide	U	S	S	-	S	S	S	-	S	S	S	S	S	S	S	S	-	S	S	S	S	S	S	M	S	S	S	
Sodium Carbonate (2%)	M	U	S	S	S	S	S	S	S	S	S	S	S	S	U	S	S	S	S	S	S	S	S	S	S	S	S	
Sodium Dodecyl Sulfate	S	S	S	-	S	S	S	-	S	S	S	S	S	S	S	-	S	S	S	S	S	S	S	S	S	S	S	S
Sodium Hypochlorite (5%)	U	U	M	S	S	M	U	S	S	M	S	S	S	M	S	S	S	S	M	S	S	S	M	U	S	M	S	
Sodium Iodide	M	S	S	-	S	S	S	-	S	S	S	S	S	S	S	-	-	S	S	S	S	S	S	M	S	S	S	
Sodium Nitrate	S	S	S	-	S	S	S	S	S	S	S	S	S	S	S	S	-	S	S	S	S	S	U	S	S	S	S	
Sodium Sulfate	U	S	S	-	S	S	S	S	S	S	S	S	S	S	S	S	S	S	S	S	S	S	S	M	S	S	S	
Sodium Sulfide	S	-	S	S	-	-	-	S	-	-	-	S	S	S	U	U	-	-	S	-	-	-	S	S	M	-	S	
Sodium Sulfite	S	S	S	-	S	S	S	S	M	S	S	S	S	S	S	M	-	S	S	S	S	S	S	S	S	S	S	
Nickel Salts	U	S	S	S	S	S	-	S	S	S	-	-	S	S	S	S	-	S	S	S	S	S	S	M	S	S	S	
Oils (Petroleum)	S	S	S	-	-	-	S	U	S	S	S	S	U	U	M	S	M	U	U	S	S	S	U	S	S	S	S	
Oils (Other)	S	-	S	-	-	-	S	M	S	S	S	S	U	S	S	S	S	U	S	S	S	S	-	S	S	M	S	
Oleic Acid	S	-	U	S	S	S	U	U	S	U	S	S	M	S	S	S	S	S	S	S	S	S	M	U	S	M	M	
Oxalic Acid	U	U	M	S	S	S	U	S	S	S	S	S	U	S	U	S	S	S	S	S	S	S	S	U	M	S	S	
Perchloric Acid (10%)	U	-	U	-	S	U	U	-	S	M	M	-	-	M	U	M	S	M	M	-	M	S	U	-	S	-	S	
Perchloric Acid (70%)	U	U	U	-	-	U	U	-	S	U	M	U	U	M	U	U	U	M	M	U	M	S	U	U	S	U	S	
Phenol (5%)	U	S	U	-	S	M	M	-	S	U	M	U	U	S	U	M	S	M	S	U	U	S	U	M	M	M	S	
Phenol (50%)	U	S	U	-	S	U	M	-	S	U	M	U	U	U	U	U	S	U	M	U	U	S	U	U	U	M	S	
Phosphoric Acid (10%)	U	U	M	S	S	S	U	S	S	S	S	U	-	S	S	S	S	S	S	S	S	S	U	M	U	S	S	
Phosphoric Acid (conc.)	U	U	M	M	-	-	U	S	-	M	S	U	U	M	M	S	S	S	M	S	M	S	U	M	U	-	S	
Physiologic Media (Serum, Urine)	M	S	S	S	-	-	S	-	S	S	S	S	S	S	S	S	S	S	S	S	S	S	S	S	S	S	S	

CHEMICAL	MATERIAL	ALUMINUM	ANODIC COATING for ALUMINIUM	BUNA N	CELLULOSE ACETATE BUTYRATE	POLYURETHANE ROTOR PAINT	COMPOSITE Carbon Fiber/Epoxy	DELRIN™	ETHYLENE PROPYLENE	GLASS	NEOPRENE	NORYL™	NYLON	PET*, POLYCLEAR™, CLEARCRIMP™, CCLLEARCRIMP™	POLYALLUMER	POLYCARBONATE	POLYESTER, GLASS THERMOSET	POLYETHERIMIDE	POLYETHYLENE	POLYPROPYLENE	POLYSULFONE	POLYVINYL CHLORIDE	RULON A™, TEFLON™	SILICONE RUBBER	STAINLESS STEEL	TITANIUM	TYGON™	VITON™
Picric Acid	S	S	U	-	S	M	S	S	S	M	S	U	S	S	S	U	S	S	S	S	U	S	U	M	S	M	S	
Pyridine (50%)	U	S	U	U	S	U	U	-	U	S	S	U	U	M	U	U	-	U	S	M	U	S	S	U	U	U	U	
Rubidium Bromide	M	S	S	-	S	S	S	-	S	S	S	S	S	S	S	-	-	S	S	S	S	S	S	M	S	S	S	
Rubidium Chloride	M	S	S	-	S	S	S	-	S	S	S	S	S	S	S	-	-	S	S	S	S	S	S	M	S	S	S	
Sucrose	M	S	S	-	S	S	S	S	S	S	S	S	S	S	S	S	S	S	S	S	S	S	S	S	S	S	S	
Sucrose, Alkaline	M	S	S	-	S	S	S	-	S	S	S	S	S	S	U	S	S	S	S	S	S	S	S	M	S	S	S	
Sulfosalicylic Acid	U	U	S	S	S	S	S	-	S	S	S	U	S	S	S	-	S	S	S	-	S	S	S	U	S	S	S	
Nitric Acid (10%)	U	S	U	S	S	U	U	-	S	U	S	U	-	S	S	S	S	S	S	S	S	S	M	S	S	S	S	
Nitric Acid (50%)	U	S	U	M	S	U	U	-	S	U	S	U	U	M	M	U	M	M	M	S	S	S	U	S	S	M	S	
Nitric Acid (95%)	U	-	U	U	-	U	U	-	-	U	U	U	U	M	U	U	U	U	M	U	U	S	U	S	S	-	S	
Hydrochloric Acid (10%)	U	U	M	S	S	S	U	-	S	S	S	U	U	S	U	S	S	S	S	S	S	S	S	U	M	S	S	
Hydrochloric Acid (50%)	U	U	U	U	S	U	U	-	S	M	S	U	U	M	U	U	S	S	S	S	M	S	M	U	U	M	M	
Sulfuric Acid (10%)	M	U	U	S	S	U	U	-	S	S	M	U	S	S	S	S	S	S	S	S	S	S	U	U	U	S	S	
Sulfuric Acid (50%)	M	U	U	U	S	U	U	-	S	S	M	U	U	S	U	U	M	S	S	S	S	S	U	U	U	M	S	
Sulfuric Acid (conc.)	M	U	U	U	-	U	U	M	-	-	M	U	U	S	U	U	U	M	S	U	M	S	U	U	U	-	S	
Stearic Acid	S	-	S	-	-	-	S	M	S	S	S	S	-	S	S	S	S	S	S	S	S	S	M	M	S	S	S	
Tetrahydrofuran	S	S	U	U	S	U	U	M	S	U	U	S	U	U	U	-	M	U	U	U	U	S	U	S	S	U	U	
Toluene	S	S	U	U	S	S	M	U	S	U	U	S	U	U	U	S	U	M	U	U	U	S	U	S	U	U	M	
Trichloroacetic Acid	U	U	U	-	S	S	U	M	S	U	S	U	U	S	M	-	M	S	S	U	U	S	U	U	U	M	U	
Trichloroethane	S	-	U	-	-	-	M	U	-	U	-	S	U	U	U	U	U	U	U	U	U	S	U	-	S	-	S	
Trichloroethylene	-	-	U	U	-	-	-	U	-	U	-	S	U	U	U	U	U	U	U	U	U	S	U	-	U	-	S	
Trisodium Phosphate	-	-	-	S	-	-	M	-	-	-	-	-	-	S	-	-	S	S	S	-	-	S	-	-	S	-	S	
Tris Buffer (neutral pH)	U	S	S	S	S	S	S	-	S	S	S	S	S	S	S	S	S	S	S	S	S	S	S	S	S	S	S	
Triton X-100™	S	S	S	-	S	S	S	-	S	S	S	S	S	S	S	S	S	S	S	S	S	S	S	S	S	S	S	
Urea	S	-	U	S	S	S	S	-	-	-	-	S	S	S	M	S	S	S	S	-	S	S	S	M	S	-	S	
Hydrogen Peroxide (10%)	U	U	M	S	S	U	U	-	S	S	S	U	S	S	S	M	U	S	S	S	S	S	S	M	S	U	S	
Hydrogen Peroxide (3%)	S	M	S	S	S	-	S	-	S	S	S	S	S	S	S	S	M	S	S	S	S	S	S	S	S	S	S	
Xylene	S	S	U	S	S	S	M	U	S	U	U	U	U	U	U	M	U	M	U	U	U	S	U	M	S	U	S	
Zinc Chloride	U	U	S	S	S	S	U	S	S	S	S	S	S	S	S	S	S	S	S	S	S	S	S	U	S	S	S	

## 9 Chemical Compatibility Chart

CHEMICAL	MATERIAL	ALUMINUM	ANODIC COATING for ALUMINIUM	BUNA N	CELLULOSE ACETATE BUTYRATE	POLYURETHANE ROTOR PAINT	COMPOSITE Carbon Fiber/Epoxy	DELRIN™	ETHYLENE PROPYLENE	GLASS	NEOPRENE	NORYL™	NYLON	PET*, POLYCLEAR™, CLEARCRIMP™, CCCCLEARCRIMP™	POLYALLOMER	POLYCARBONATE	POLYESTER, GLASS THERMOSET	POLYETHERIMIDE	POLYETHYLENE	POLYPROPYLENE	POLYSULFONE	POLYVINYL CHLORIDE	RULON A™, TEFLO™	SILICONE RUBBER	STAINLESS STEEL	TITANIUM	TYGON™	VITON™
Zinc Sulfate		U	S	S	-	S	S	S	S	S	S	S	S	S	S	S	S	S	S	S	S	S	S	S	S	S	S	S
Citric Acid (10%)		M	S	S	M	S	S	M	S	S	S	S	S	S	S	S	S	M	S	S	S	S	S	S	S	S	S	S

\* Polyethyleneterephthalate

### Key

S Satisfactory

M M = Moderate attack, may be satisfactory for use in centrifuge depending on length of exposure, speed involved, etc.; suggest testing under actual conditions of use.

U U = Unsatisfactory, not recommended.

-- No data available. Because no organized chemical resistance data exists for materials under the stress of centrifugation, when in doubt we recommend pretesting sample lots. suggest testing, using sample to avoid loss of valuable material.

Chemical resistance data is included only as a guide to product use.

## Contact

Country	Telephone number
United States / Canada	+1 866 984 3766
Latin America	+1 866 984 3766
Austria	+43 1 801 40 0
Belgium	+32 53 73 42 41
Germany	0800 1 536 376 +49 6184 90 6000
France	+33 2 2803 2180
Italy	+39 02 95059 552
Netherlands	+31 76 579 55 55
Nordic / Baltic Countries / CIS	+358 9 329 10200
Russia	+7 812 703 42 15
Spain / Portugal	+34 93 223 09 18
Switzerland	+41 44 454 12 22
UK / Ireland	+44 870 609 9203
China	+86 21 6865 4588 +86 10 8419 3588
India	+91 22 6716 2200
Japan	+81 45 453 9220
Other Asian Countries	+852 2885 4613
Australia	+61 39757 4300
New Zealand	+64 9 980 6700
Countries not listed	+49 6184 90 6000 +33 2 2803 2180





**A**

Accident Prevention 10  
Aerosol-tight Rotors 38  
Aligning the Centrifuge 23  
Autoclaving 50

**B**

Bucket selection 34

**C**

Care 45  
Centrifugation 35  
Cleaning 46  
Cleaning Intervals 46  
Close Lid 30  
Contact 65  
Continuous Operation 34  
Control Panel 28

**D**

Decontamination 49  
Disinfection 48  
Disposal 51

**E**

Emergency Door Release 54  
Entering Parameters 32  
Explanation of RCF Value 33

**F**

Failure message 55  
Features 19

**I**

Imbalance indicator 35

**K**

Keys 28  
Kundendienst 50, 57

**L**

Lid Opening 30  
Location 22

**M**

Mains Connection 24  
Mains Supply 24  
Maintenance 45  
Maximum Loading 35

**O**

Operation 29

**P**

Preface 9  
Preselecting Speed 33

**R**

Removing the Rotor 37  
Rotor Installation 31  
Rotor Selection 20  
Running time preselection 34

**S**

Safety features 16  
Safety zone 22  
Shipping the Centrifuge 25  
Short-term Centrifugation 37  
Starting centrifuge program 35  
Stopping the centrifugation program 36  
Storage 24  
Switch on Centrifuge 30

**T**

Technical Data 17  
Thermo Fisher Scientific Service 50  
Transporting the Centrifuge 23  
Trouble Shooting 53

**W**

WEEE Compliance 5

